

## Glass Passivated Single-Phase Bridge Rectifier

### FEATURES

- Ideal for printed circuit board
- High case dielectric strength of 1500 VRMS
- High surge current capability
- Typical IR less than 0.1 $\mu$ A
- UL Recognized File # E-326243
- Compliant to RoHS Directive 2011/65/EU and in accordance to WEEE 2002/96/EC
- Halogen-free according to IEC 61249-2-21 definition
- AEC-Q101 qualified

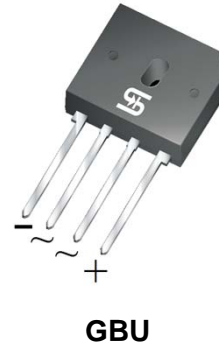

### MECHANICAL DATA

**Case:** GBU

Molding compound, UL flammability classification rating 94V-0

Packing code with suffix "G" means green compound (halogen-free)

**Terminal:** Matte tin plated leads, solderable per JESD22-B102

**Polarity:** As marked

**Weight:** 4 g (approximately)

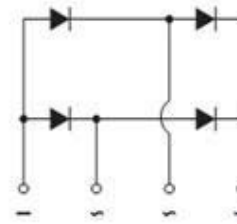

MAXIMUM RATINGS AND ELECTRICAL CHARACTERISTICS (T <sub>A</sub> =25°C unless otherwise noted)									
PARAMETER	SYMBOL	GBU 601	GBU 602	GBU 603	GBU 604	GBU 605	GBU 606	GBU 607	UNIT
Maximum repetitive peak reverse voltage	V <sub>RRM</sub>	50	100	200	400	600	800	1000	V
Maximum RMS voltage	V <sub>RMS</sub>	35	70	140	280	420	560	700	V
Maximum DC blocking voltage	V <sub>DC</sub>	50	100	200	400	600	800	1000	V
Maximum average forward rectified current	I <sub>F(AV)</sub>	6							A
Peak forward surge current, 8.3 ms single half sine-wave	I <sub>FSM</sub>	175							A
Rating of fusing ( t<8.3ms)	I <sup>2</sup> t	127							A <sup>2</sup> s
Maximum Instantaneous Forward Voltage (Note 1) I <sub>F</sub> = 3 A I <sub>F</sub> = 6 A	V <sub>F</sub>					1.0 1.1			V
Maximum reverse current @ rated VR T <sub>J</sub> =25 °C T <sub>J</sub> =125 °C	I <sub>R</sub>	5 500							$\mu$ A
Typical junction capacitance per leg (Note 2)	C <sub>J</sub>	211				94			pF
Typical thermal resistance	R <sub><math>\theta</math>JC</sub> R <sub><math>\theta</math>JA</sub>					2 21			°C/W
Operating junction temperature range	T <sub>J</sub>	- 55 to +150							°C
Storage temperature range	T <sub>STG</sub>	- 55 to +150							°C

Note 1: Pulse test with PW=300 $\mu$ s, 1% duty cycle

Note 2: Measured at 1MHz and applied Reverse bias of 4.0V DC

ORDERING INFORMATION				
PART NO.	PACKING CODE	PACKING CODE SUFFIX	PACKAGE	PACKING
GBU60x (Note 1)	C2	G	GBU	20 / Tube
	D2			20 / Tube
	X0			Forming

Note 1: "x" defines voltage from 50V (GBU601) to 1000V (GBU607)

EXAMPLE				
PREFERRED PART NO.	PART NO.	PACKING CODE	PACKING CODE SUFFIX	DESCRIPTION
GBU606 C2	GBU606	C2		AEC-Q101 qualified
GBU606 C2G	GBU606	C2	G	AEC-Q101 qualified Green compound

**RATINGS AND CHARACTERISTICS CURVES**

(T<sub>A</sub>=25°C unless otherwise noted)

FIG. 1 FORWARD CURRENT DERATING CURVE

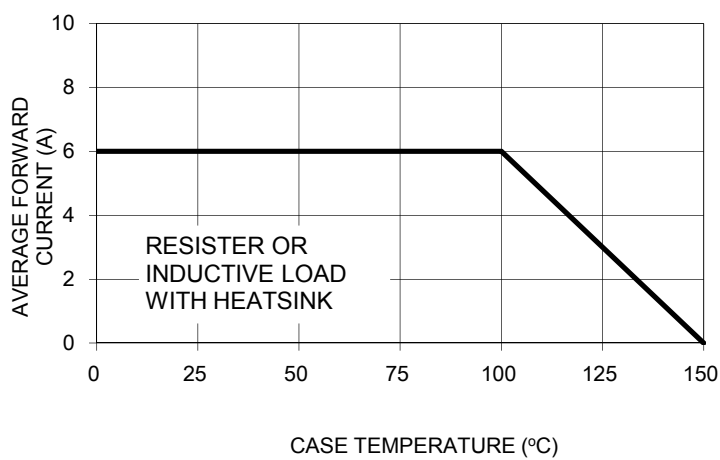

FIG. 2 MAXIMUM NON-REPETITIVE FORWARD SURGE CURRENT

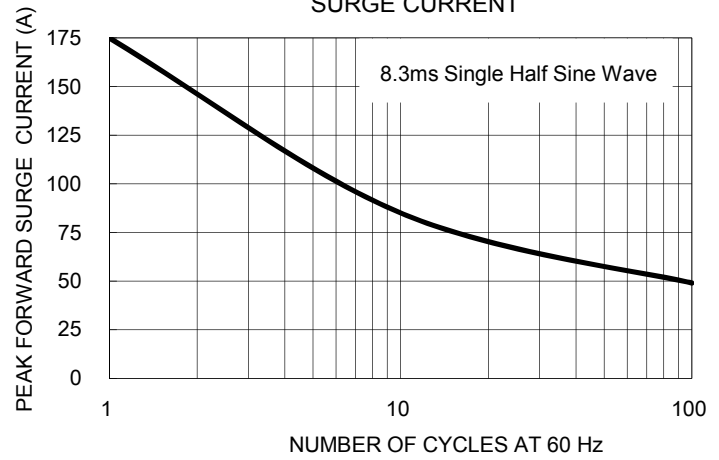

FIG. 3 TYPICAL REVERSE CHARACTERISTICS

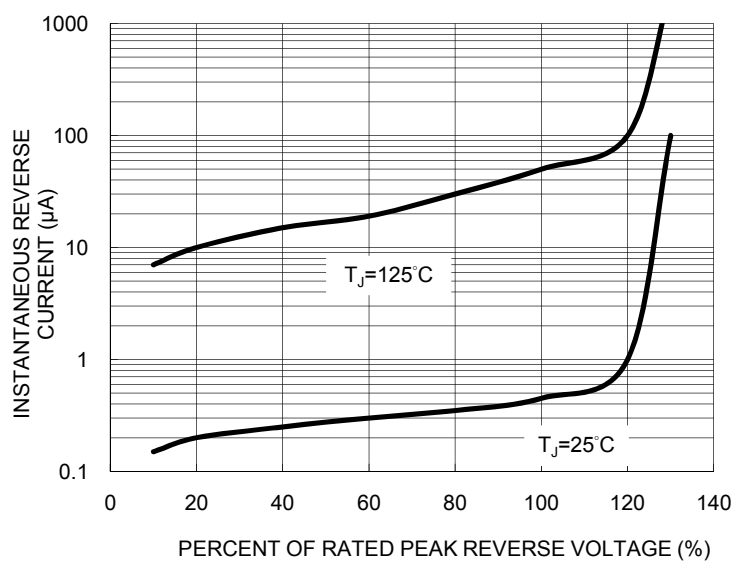

FIG. 4 TYPICAL FORWARD CHARACTERISTICS

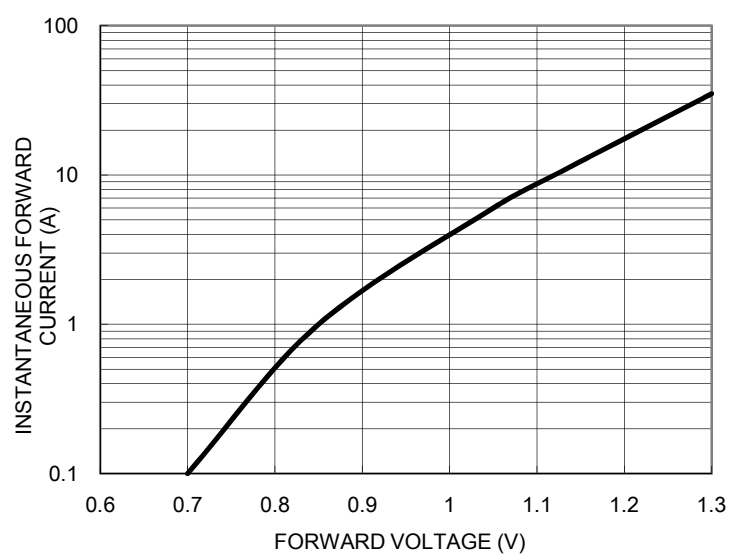
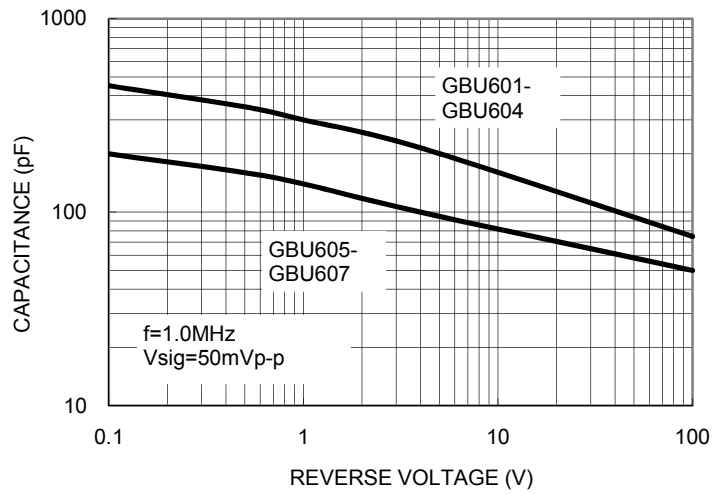
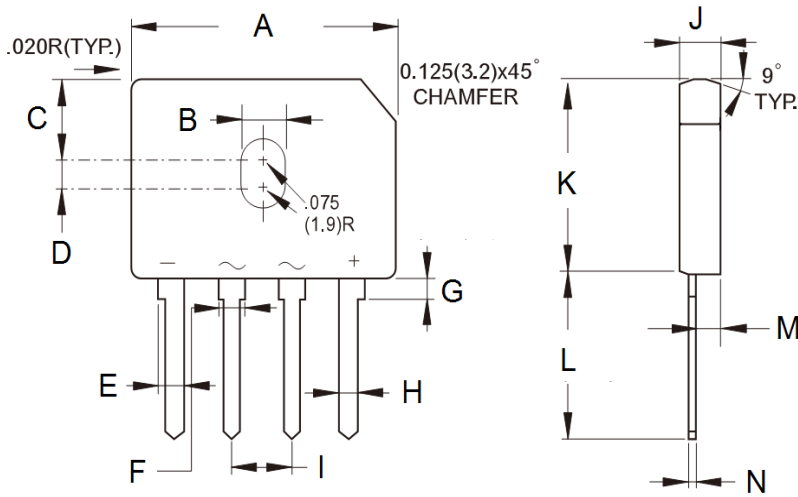

FIG. 5 TYPICAL JUNCTION CAPACITANCE



PACKAGE OUTLINE DIMENSIONS

**GBU**



DIM.	Unit (mm)		Unit (inch)	
	Min	Max	Min	Max
A	21.80	22.30	0.858	0.878
B	3.50	4.10	0.138	0.161
C	7.40	7.90	0.291	0.311
D	1.65	2.16	0.065	0.085
E	2.16	2.54	0.085	0.100
F	1.65	2.03	0.065	0.080
G	1.52	2.03	0.060	0.080
H	1.02	1.27	0.040	0.050
I	4.83	5.33	0.190	0.210
J	3.30	3.56	0.130	0.140
K	18.30	18.80	0.720	0.740
L	17.50	18.00	0.689	0.709
M	1.90	2.16	0.075	0.085
N	0.46	0.56	0.018	0.022

MARKING DIAGRAM

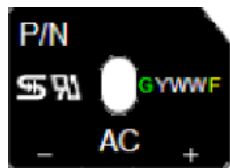

- P/N = Specific Device Code
- G = Green Compound
- YW = Date Code
- F = Factory Code

## Notice

Specifications of the products displayed herein are subject to change without notice. TSC or anyone on its behalf, assumes no responsibility or liability for any errors or inaccuracies.

Information contained herein is intended to provide a product description only. No license, express or implied, to any intellectual property rights is granted by this document. Except as provided in TSC's terms and conditions of sale for such products, TSC assumes no liability whatsoever, and disclaims any express or implied warranty, relating to sale and/or use of TSC products including liability or warranties relating to fitness for a particular purpose, merchantability, or infringement of any patent, copyright, or other intellectual property right.

The products shown herein are not designed for use in medical, life-saving, or life-sustaining applications. Customers using or selling these products for use in such applications do so at their own risk and agree to fully indemnify TSC for any damages resulting from such improper use or sale.